



LÜCK Bilderrahmen



Katalog 2019

Bilderrahmen | Passepartouts | Galerierahmen | Wandalben | Maßanfertigungen

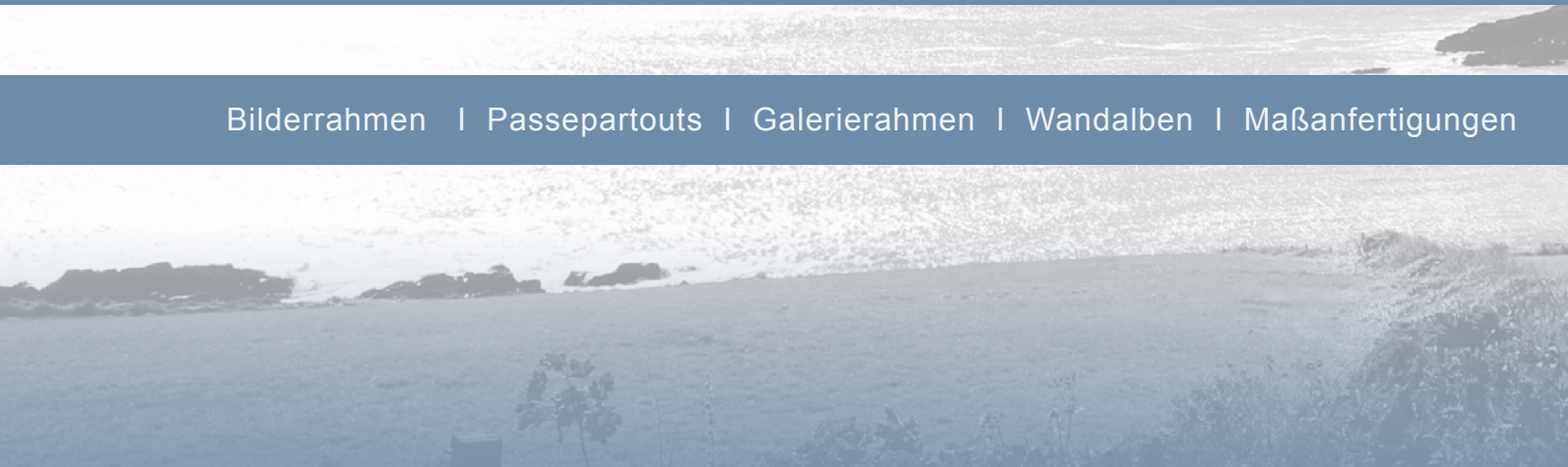

MDF-HOLZRAHMEN	3
ANSBACH	3
COBURG	4
WÜRZBURG	5
ALTÖTTING	6
KUNSTSTOFFRAHMEN	7
AUGSBURG	7
GARMISCH	8
DEGGENDORF	9
FREISING	10
WEILHEIM	11
LANDSHUT	12
NÜRNBERG	14
FRIEDBERG	16
BAMBERG	18
FÜRTH	19
ERDING	20
BAYREUTH	21
BERCHTESGADEN	22
MÜNCHEN	23
CLASSIC	24
ALURAHMEN	25
HOUSTON	25
CLIPRAHMEN	26
PASSEPARTOUTS	27
PASSEPARTOUTS - GALERIEN	29
PASSEPARTOUTS - WANDTAFELN	33
PASSBILDMAPPEN	39
AGB	40



L 359



L 357



L 358



L 359



L 360



L 361



L 362

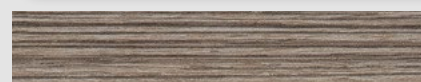

L 363



L 364



L 365



L 366



L 377



L 378

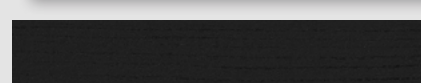



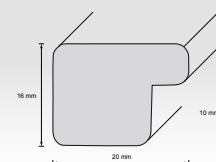

L 379

Leistenbreite	20 mm	Preisgruppe	18
Leistenhöhe	16 mm		
Falzmaß	10 mm		
Material	MDF		





L 034

-  L 025
-  L 026
-  L 027
-  L 028
-  L 029 matt
-  L 030 silver
-  L 034
-  L 036
-  L 037
-  L 087
-  L 088
-  L 089
-  L 090
-  L 091
-  L 092
-  L 093

-  L 095 silver
-  L 096
-  L 099

Leistenbreite	22 mm
Leistenhöhe	17 mm
Falzmaß	10 mm
Material	MDF
Preisgruppe	30

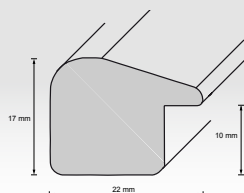



L 716



L 713



L 714

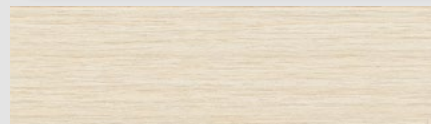

L 715

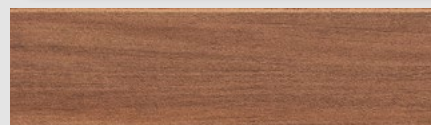

L 716

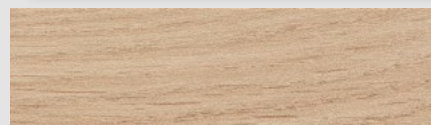

L 717



L 718

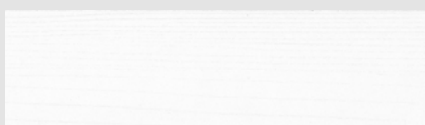

L 722



L 723

silber

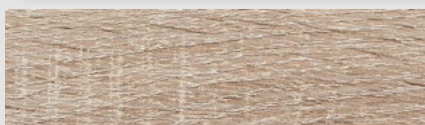

L 724

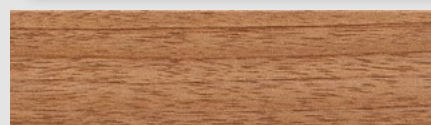

L 719

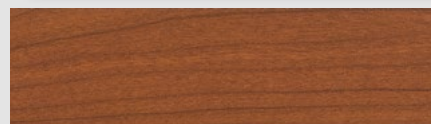

L 720

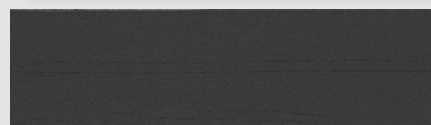

L 721

Leistenbreite	35 mm	Preisgruppe	38
Leistenhöhe	23 mm		
Falzmaß	15 mm		
Material	MDF		

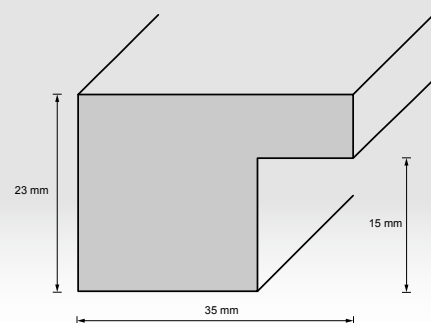

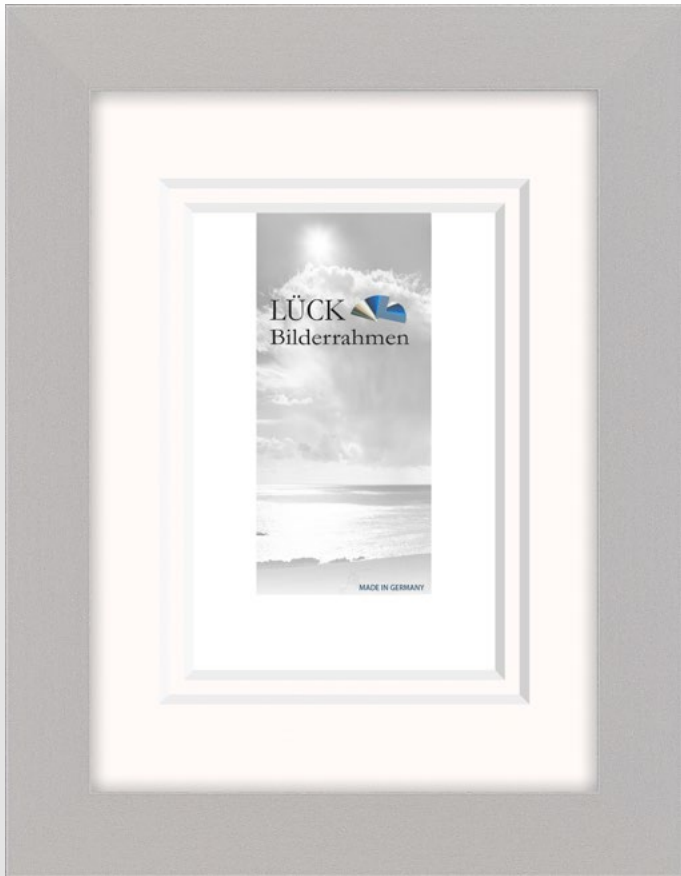

L 166



L 166



L 167



L 168



L 16880



L 16896



L 169



L 171

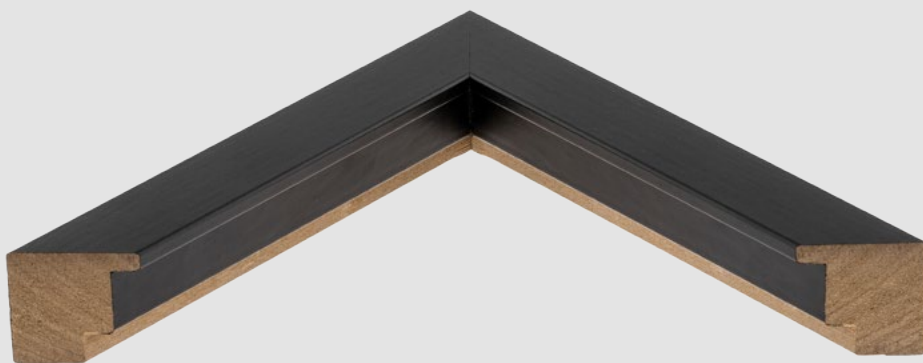

Leistenbreite	22 mm
Leistenhöhe	32 mm
Falzmaß 1	10 mm
Falzmaß 2	18 mm
Material	MDF

Preisgruppe 27

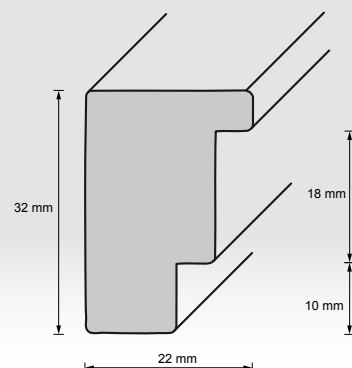



L 970



L 971



L 972



L 973



L 974



L 975



L 976

L 970



Leistenbreite | 16 mm
Leistenhöhe | 20 mm
Falzmaß | 10 mm
Material | Kunststoff

Preisgruppe | 31

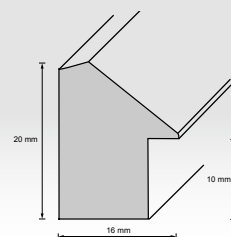



L 941



L 940



L 941



L 942



L 943



L 944



L 945

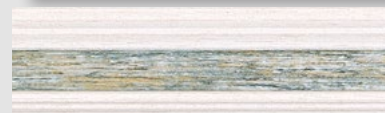

L 946

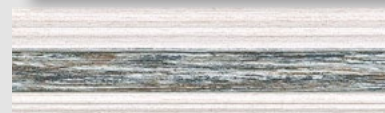

L 947

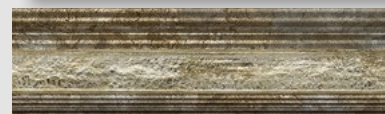

L 948



Leistenbreite	26 mm	Preisgruppe	31
Leistenhöhe	18 mm		
Falzmaß	8 mm		
Material	Kunststoff		

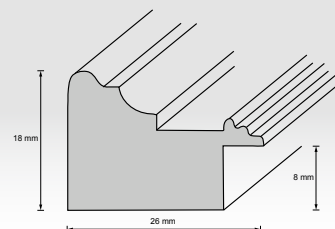



L 890



L 891



L 892



L 893



L 894



L 895

L 890



Leistenbreite	16 mm
Leistenhöhe	20 mm
Falzmaß	9 mm
Material	Kunststoff

Preisgruppe 30

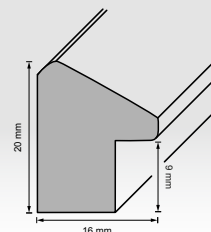



L 293

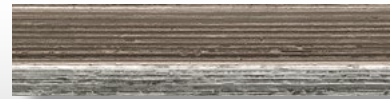

L 293



L 294



L 295



L 296

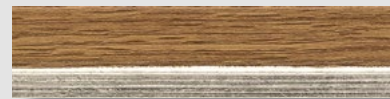

L 298



L 299



Leistenbreite	21mm	Preisgruppe	30
Leistenhöhe	14 mm		
Falzmaß	9 mm		
Material	Kunststoff		

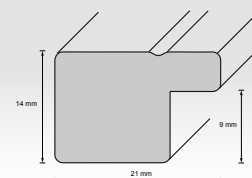



L 764



L 760



L 762



L 763



L 764



L 765



L 766



L 767



L 768



L 769-2

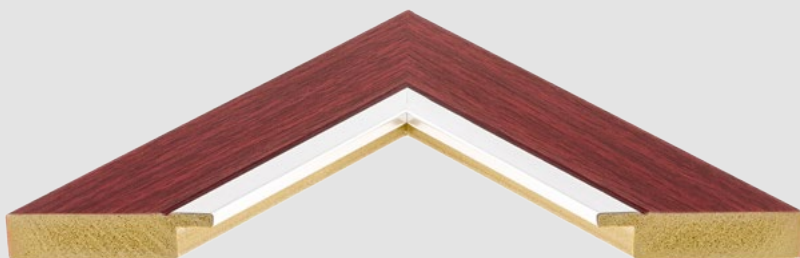

Leistenbreite	37 mm	Preisgruppe	27
Leistenhöhe	17 mm		
Falzmaß	13 mm		
Material	Kunststoff		

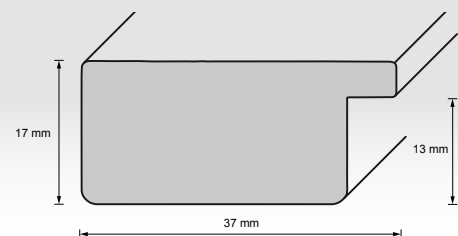



L 279

L 391

L 277





L 274



L 285



L 275

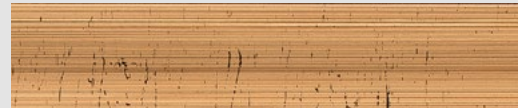

L 287



L 277



L 288

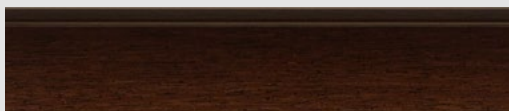

L 278



L 289

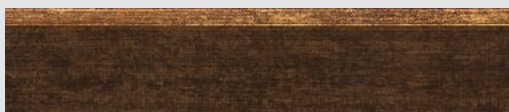

L 279



L 290

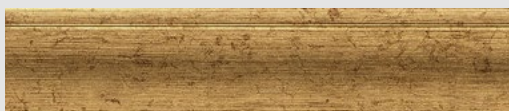

L 280

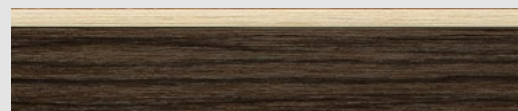

L 390



L 282



L 391



L 283

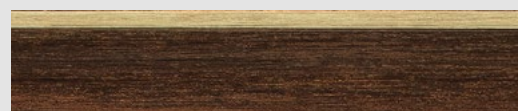

L 392



L 995

Leistenbreite	24 mm
Leistenhöhe	19 mm
Falzmaß	11 mm
Material	Kunststoff

Preisgruppe 31

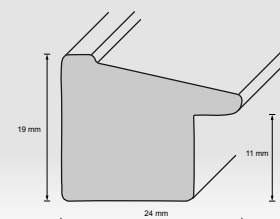



L 854

L 804

Leistenbreite	42 mm	Preisgruppe	27
Leistenhöhe	20 mm		
Falzmaß	9 mm		
Material	Kunststoff		

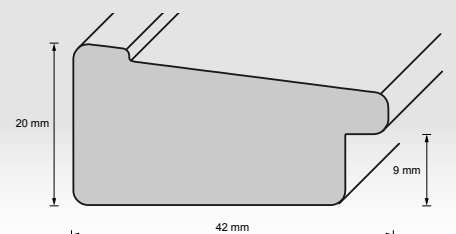



L 800

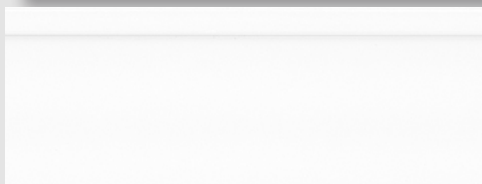

L 801



L 802

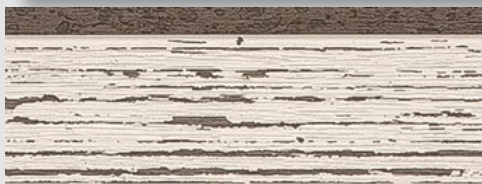

L 803

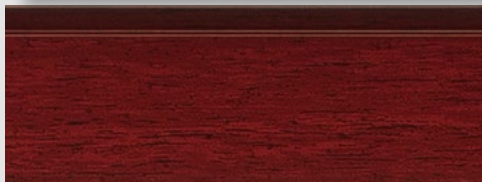

L 804

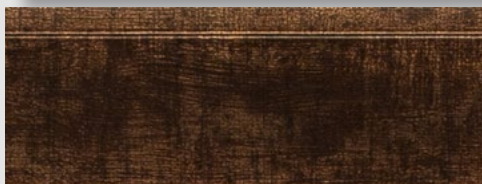

L 845



L 846



L 847



L 849



L 851

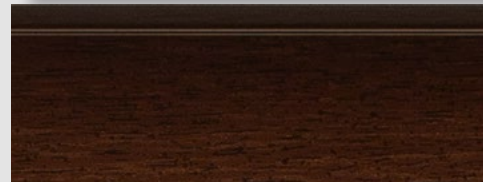

L 852

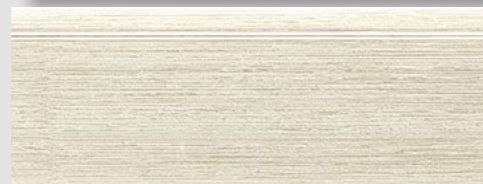

L 853



L 854



L 855-2



L 856-2



L 857-2



L 992

L 990

L 394

Leistenbreite	30 mm	Preisgruppe	38
Leistenhöhe	16 mm		
Falzmaß	10 mm		
Material	Kunststoff		

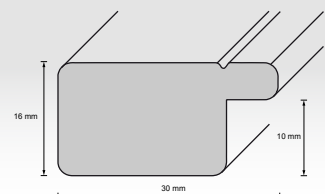



L 367



L 369

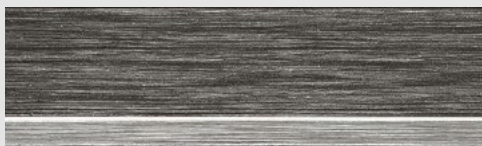

L 393

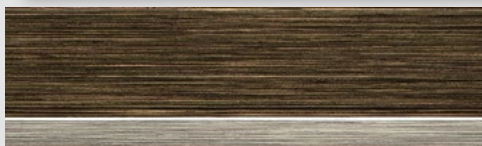

L 394

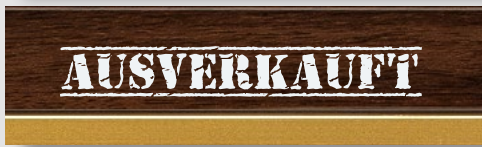

L 395



L 396



L 397

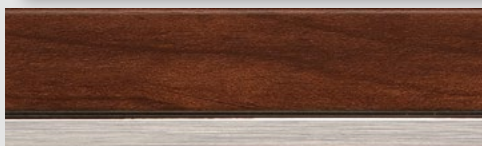

L 398

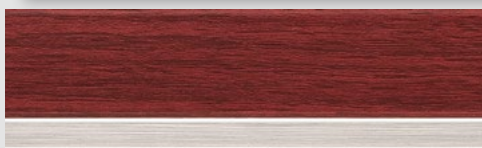

L 405



L 406



L 407



L 408



L 409



L 990



L 991

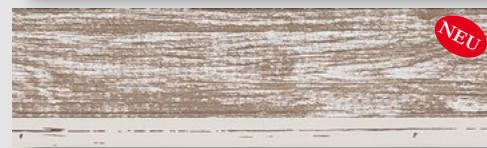

L 992



L 993



L 994

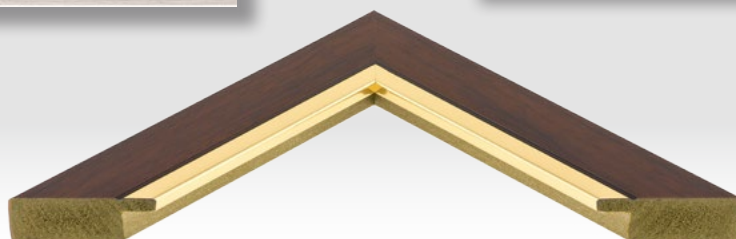

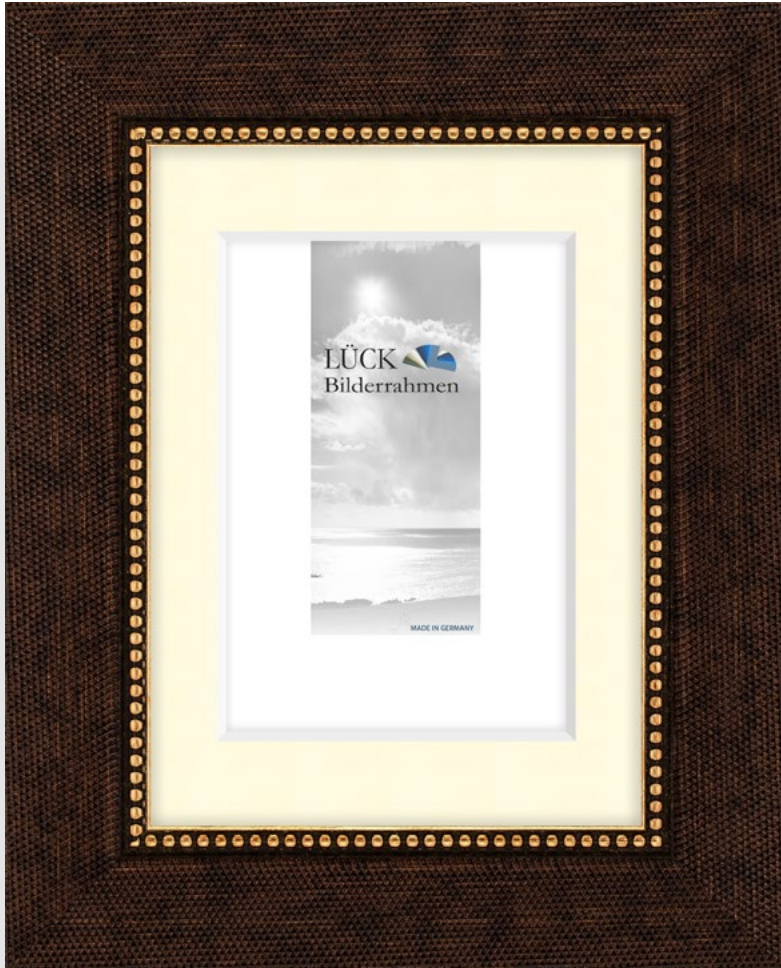

L 663

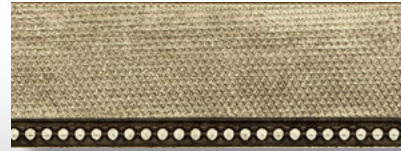

L 660



L 661



L 662

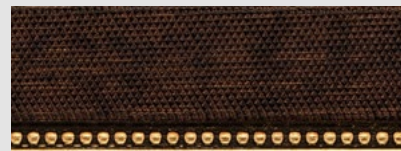

L 663



Leistenbreite	39 mm	Preisgruppe	38
Leistenhöhe	14 mm		
Falzmaß	7 mm		
Material	Kunststoff		

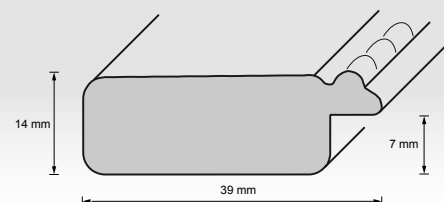



L 380



L 381



L 382

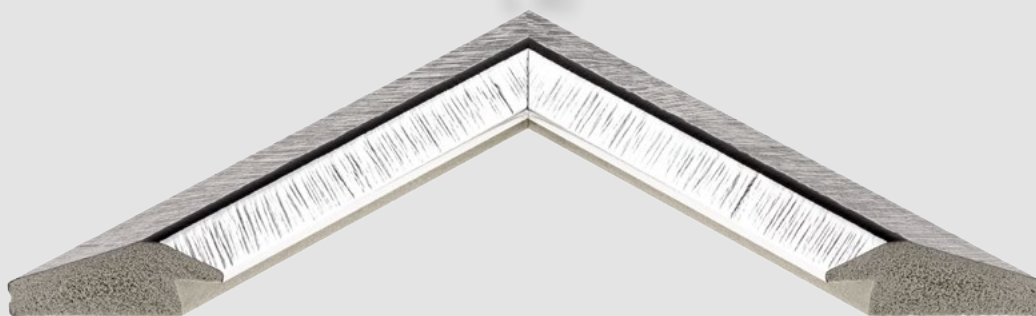

Leistenbreite 31 mm
Leistenhöhe 20 mm
Falzmaß 9 mm
Material Kunststoff

Preisgruppe 31

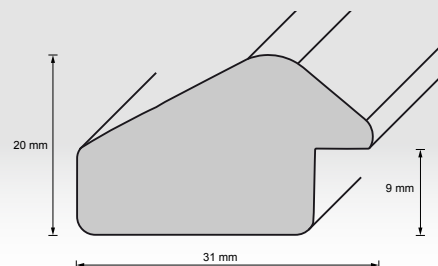



L 370



L 371



L 372



L 373



L 374

L 371



Leistenbreite	22 mm	Preisgruppe 31
Leistenhöhe	19 mm	
Falzmaß	7 mm	
Material	Kunststoff	

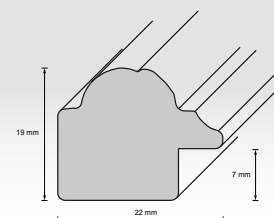



L 105

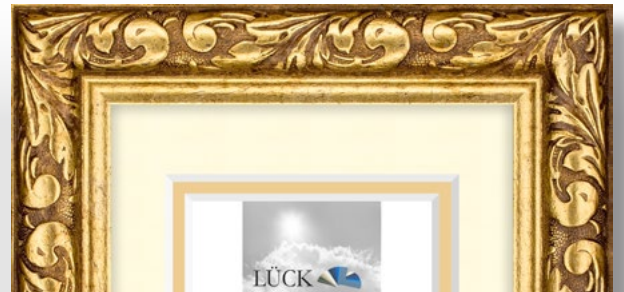

L 106



L 107



L 108



NEU

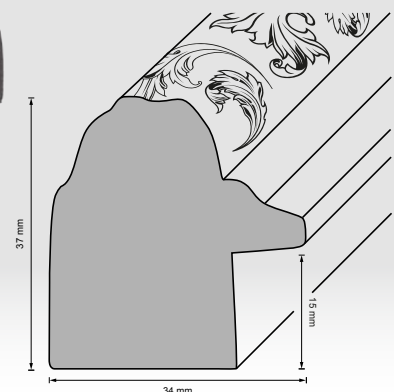

Leistenbreite	34 mm	Preisgruppe	27
Leistenhöhe	37 mm		
Falzmaß	15 mm		
Material	Kunststoff		



L 117

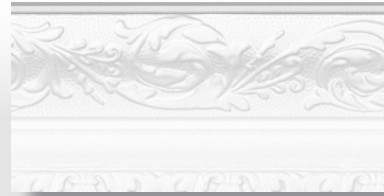

L 115



L 116



L 117



L 148



L 149



Leistenbreite	64 mm
Leistenhöhe	35 mm
Falzmaß	11 mm
Material	Kunststoff

Preisgruppe	23
--------------------	----

35 mm

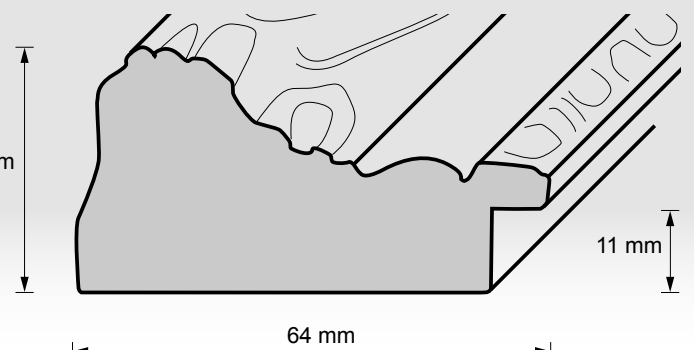



L 195



L 196



L 197



L 198



L 199

L 197



Leistenbreite	38 mm
Leistenhöhe	22 mm
Falzmaß	11 mm
Material	Kunststoff

Preisgruppe 32

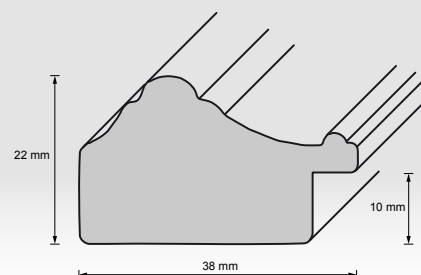

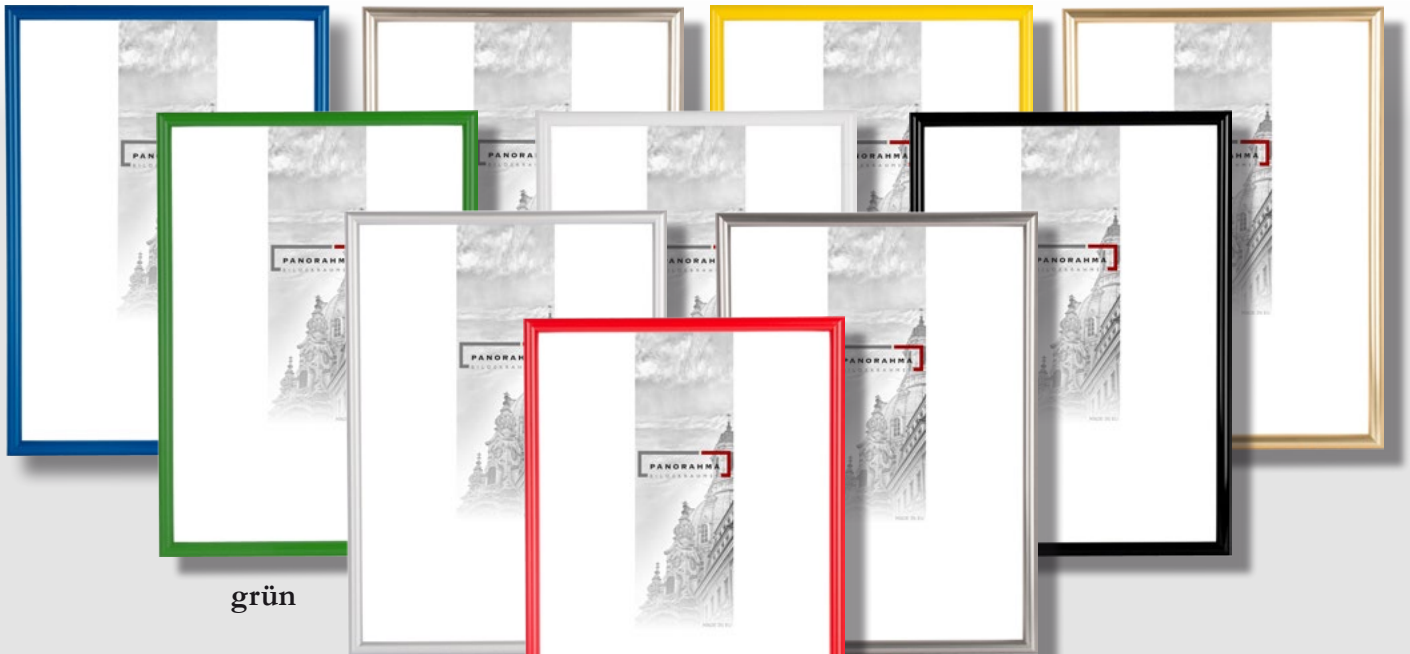

grün



weiß
gelb
rot
blau
schwarz

gold
champagner
Auslauf
stahl
silber matt

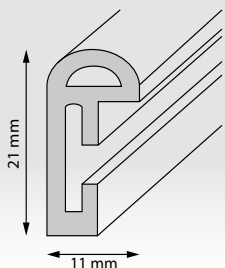

Formate	10x15 13x18 15x20 18x24 20x20 20x28 20x30 21x29,7 DIN A4 24x30	28x35 29,7x42 DIN A3 30x30 30x40 30x45 40x40 40x50 40x60 42x59,4 DIN A2	50x50 50x60 50x70 50x75 59,4x84 DIN A1 60x80 62x93 50x100 70x100
Material	Kunststoff		
Leistenbreite	11 mm		
Leistenhöhe	21 mm		
Preise:	Bitte der Preisliste entnehmen.		



Formate

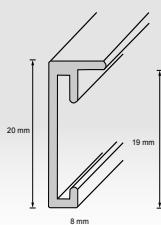

Material
Leistenbreite
Leistenhöhe

13x18
14,8x21 DIN A5
18x24
20x20
21x29,7 DIN A4
24x30
29,7x42 DIN A3
30x30
30x40

Aluminium
8 mm
20 mm

40x40
40x50
42x59,4 DIN A2
50x60
50x70
59,4x84 DIN A1
60x80
70x100

Preisgruppe ALU 1

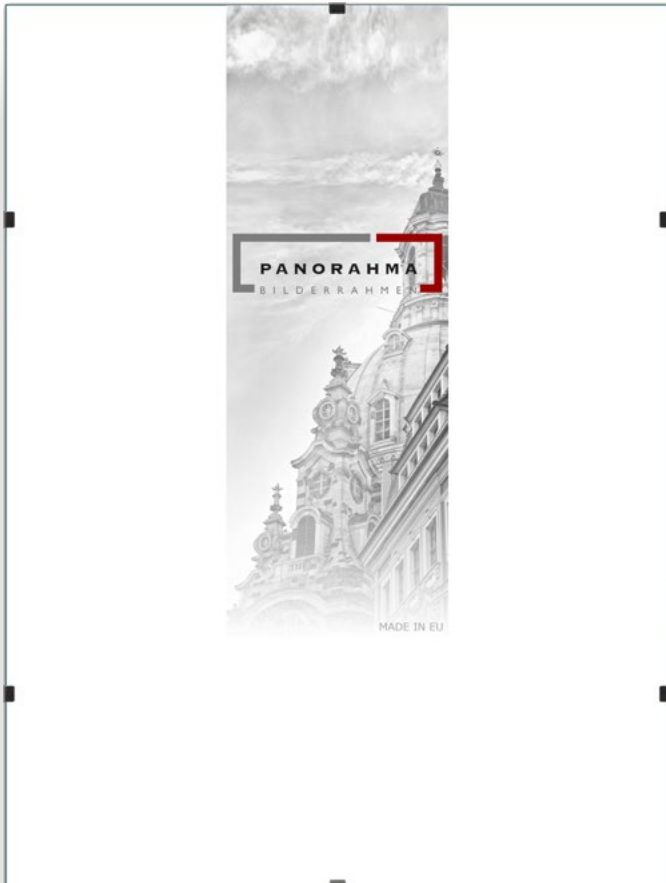

Formate

10,5x15

13x18

15x21 DIN A5

18x24

20x20

20x28

20x30

21x29,7 DIN A4

24x30

28x35

29,7x42 DIN A3

30x30

30x40

30x45

40x40

40x50

40x60

42x59,4 DIN A2

50x50

50x60

50x70

50x75

59,4x84 DIN A1

60x80

62x93

70x90

70x100

Material

Normalglas

Antireflexglas

MDF Rückwand

Preise:

Bitte der Preisliste entnehmen.

Die hier abgebildeten Passepartouts stellen nur einen kleinen Teil der vorrätigen Farbtöne dar. Weitere Farbnuancen finden Sie auf unserer Homepage.

- Weißer Kern
- Stärke: 1,3 mm
- Ideal für dekorative Einrahmungen
- Gleichmäßig gefärbte Oberflächen
- Der helle, weiße Kern betont die Schnittkante des Passepartouts
- Gepuffert mit Kalziumkarbonat
- Alle Farbtöne erhältlich bis 81x102 cm



6000 Meissen Weiss



6001 Mineralweiss



6002 Altweiss



6003 Patina Weiss

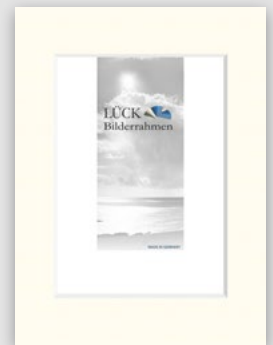

6004 Elfenbein

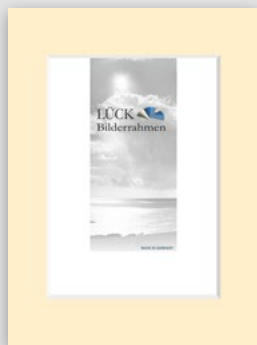

6005 Sandstein



6099 Pergament

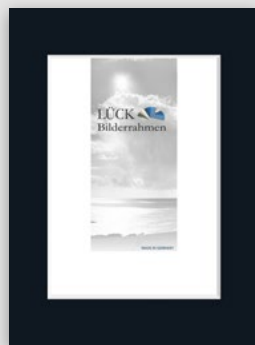

6100 Phantomschwarz



6101 Muschel



6102 Leitzgrau

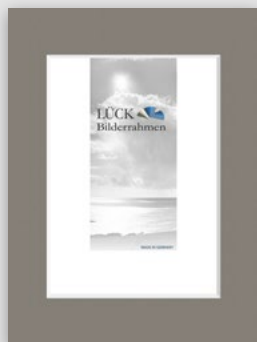

6103 Schiefer



553 Grau



6200 Marineblau



6202 Südseeblau



6203 Mykonosblau

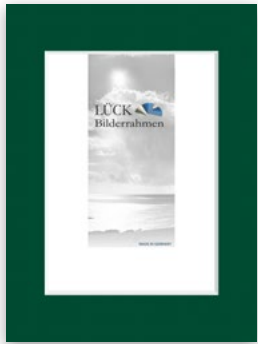

6300 Piniengrün



6301 Mokkabraun



6302 Moosgrün



6303 Pistaziengrün



6304 Trüffel

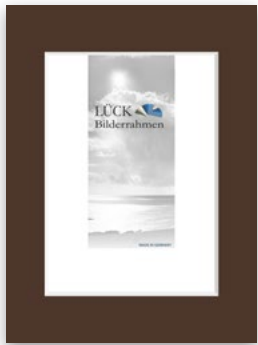

6400 Schokobraun



6401 Sand



6402 Sepia

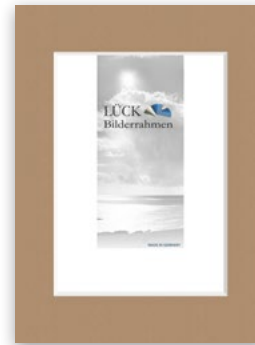

6403 Delphingrau



6405 Espresso



6406 Pflaster

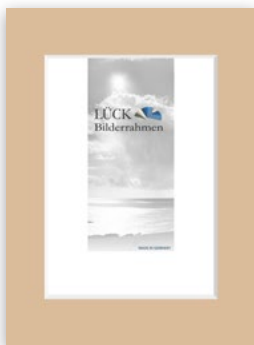

6407 Zement

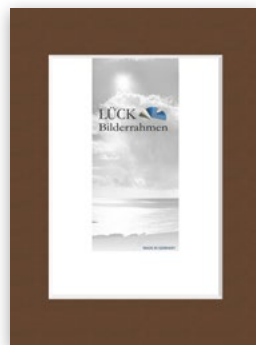

6408 Haselnuss



6409 Lachs



6410 Kamelhaar



6500 Rot



6501 Bordeaux



6502 Feuerrot



6600 Maisgelb

- Passepartout-Galerien können in allen vorrätigen Kartonarten und Farbvarianten bestellt werden.
- Preise für Bilderrahmen inkl. Passepartout-Galerien entnehmen Sie bitte der Preisliste aus der Kategorie „Preisgruppe Galerieformate“
- Benötigen Sie ein einzelnes Passepartout ohne Bilderrahmen, erfragen Sie bitte die Preise bei unserem Innendienst.



PP	Design	Bilder	Größe
Einzel	4200	2x 10x15	25x37,5
Doppel	5200	2x 10x15	25x37,5

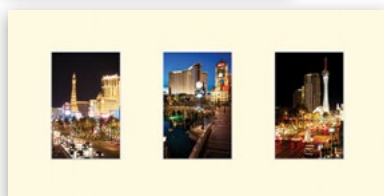

PP	Design	Bilder	Größe
Einzel	4201	3x 10x15	25x50
Doppel	5201	3x 10x15	25x50

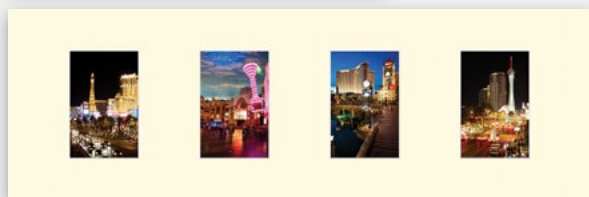

PP	Design	Bilder	Größe
Einzel	4202	4x 10x15	25x77
Doppel	5202	4x 10x15	25x77

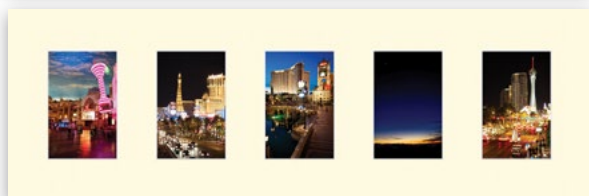

PP	Design	Bilder	Größe
Einzel	4203	5x 10x15	25x77
Doppel	5203	5x 10x15	25x77

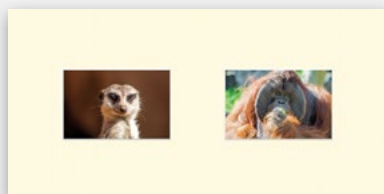

PP	Design	Bilder	Größe
Einzel	4212	2x 10x15	25x50
Doppel	5212	2x 10x15	25x50

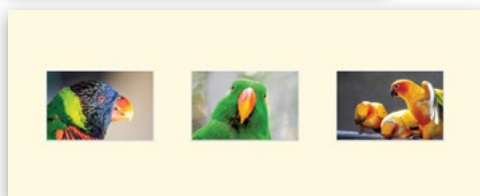

PP	Design	Bilder	Größe
Einzel	4213	3x 10x15	25x62,5
Doppel	5213	3x 10x15	25x62,5

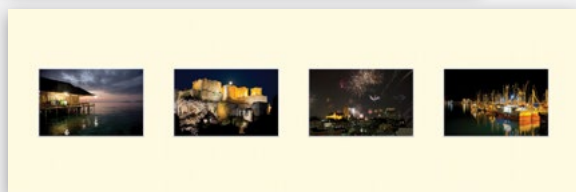

PP	Design	Bilder	Größe
Einzel	4214	4x 10x15	25x77
Doppel	5214	4x 10x15	25x77

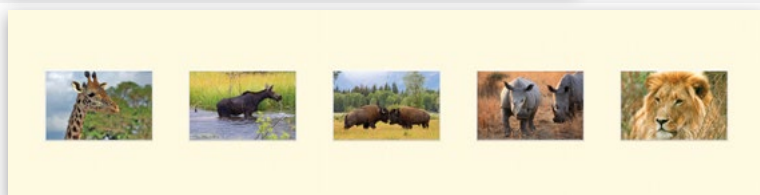

PP	Design	Bilder	Größe
Einzel	4215	5x 10x15	25x100
Doppel	5215	5x 10x15	25x100

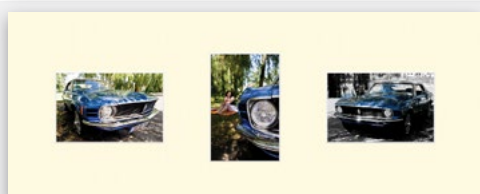

PP	Design	Bilder	Größe
Einzel	4248	3x 10x15	25x62,5
Doppel	5248	3x 10x15	25x62,5



PP	Design	Bilder	Größe
Einzel	4251	3x 10x15	25x50
Doppel	5251	3x 10x15	25x50

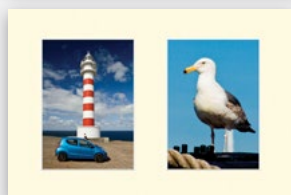

PP	Design	Bilder	Größe
Einzel	4204	2x 13x18	25x37,5
Doppel	5204	2x 13x18	25x37,5

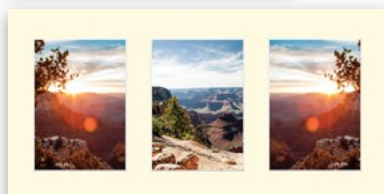

PP	Design	Bilder	Größe
Einzel	4205	3x 13x18	25x50
Doppel	5205	3x 13x18	25x50

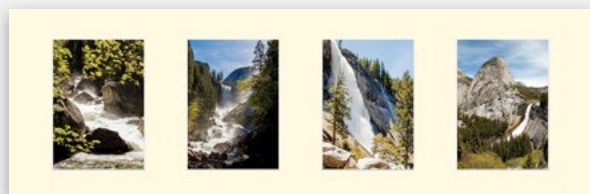

PP	Design	Bilder	Größe
Einzel	4206	4x 13x18	25x77
Doppel	5206	4x 13x18	25x77

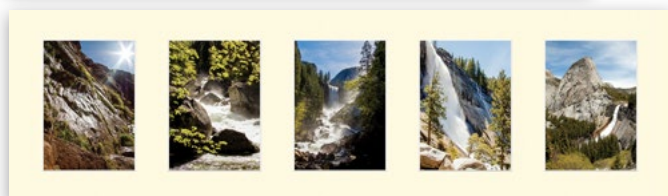

PP	Design	Bilder	Größe
Einzel	4207	5x 13x18	25x87,5
Doppel	5207	5x 13x18	25x87,5

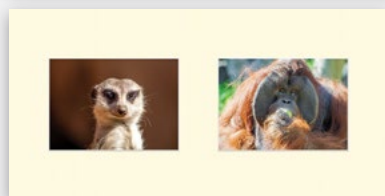

PP	Design	Bilder	Größe
Einzel	4216	2x 13x18	25x50
Doppel	5216	2x 13x18	25x50

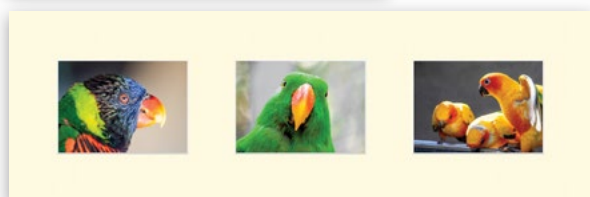

PP	Design	Bilder	Größe
Einzel	4217	3x 13x18	25x77
Doppel	5217	3x 13x18	25x77

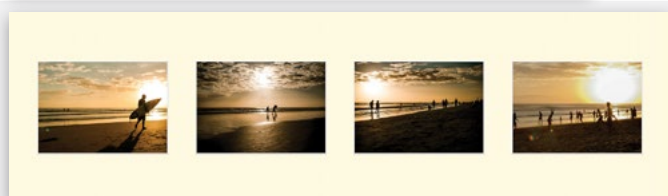

PP	Design	Bilder	Größe
Einzel	4218	4x 13x18	25x87,5
Doppel	5218	4x 13x18	25x87,5

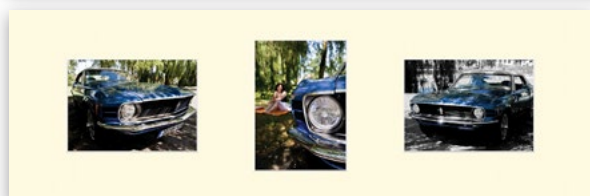

PP	Design	Bilder	Größe
Einzel	4249	3x 13x18	25x77
Doppel	5249	3x 13x18	25x77



PP	Design	Bilder	Größe
Einzel	4252	3x 13x18	25x77
Doppel	5252	3x 13x18	25x77

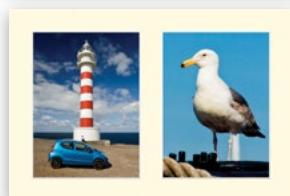

PP	Design	Bilder	Größe
Einzel	4208	2x 15x20	25x37,5
Doppel	5208	2x 15x20	25x37,5

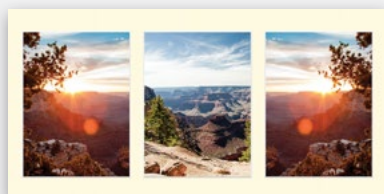

PP	Design	Bilder	Größe
Einzel	4209	3x 15x20	25x50
Doppel	5209	3x 15x20	25x50

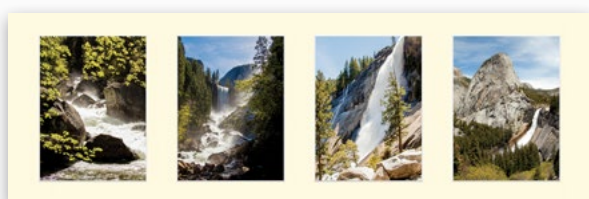

PP	Design	Bilder	Größe
Einzel	4210	4x 15x20	25x77
Doppel	5210	4x 15x20	25x77

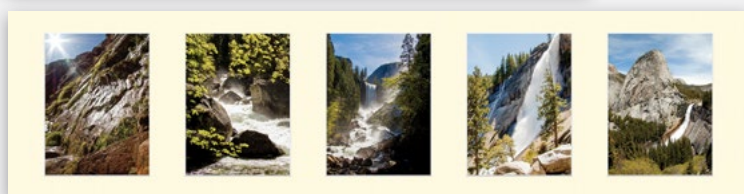

PP	Design	Bilder	Größe
Einzel	4211	5x 15x20	25x100
Doppel	5211	5x 15x20	25x100

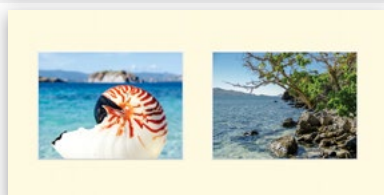

PP	Design	Bilder	Größe
Einzel	4220	2x 15x20	25x50
Doppel	5220	2 x15x20	25x50

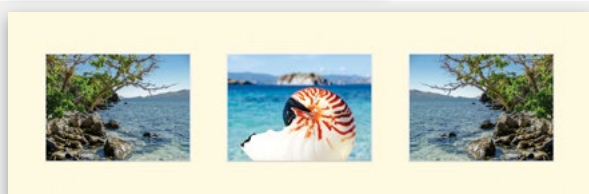

PP	Design	Bilder	Größe
Einzel	4221	3x 15x20	25x77
Doppel	5221	3x 15x20	25x77

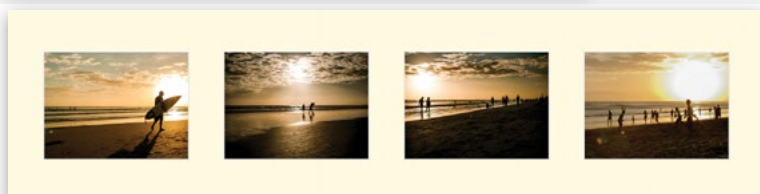

PP	Design	Bilder	Größe
Einzel	4222	4x 15x20	25x100
Doppel	5222	4x 15x20	25x100

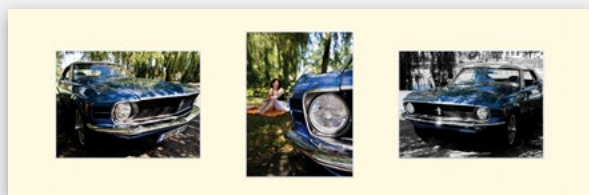

PP	Design	Bilder	Größe
Einzel	4250	3x 15x20	25x77
Doppel	5250	3x 15x20	25x77

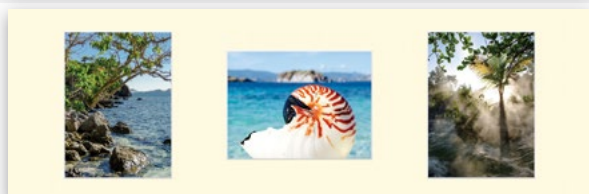

PP	Design	Bilder	Größe
Einzel	4253	3x 15x20	25x77
Doppel	5253	3x 15x20	25x77

- Passepartout-Wandtafeln können in allen vorrätigen Kartonarten und Farbvarianten bestellt werden.
- Preise für Bilderrahmen inkl. Passepartout-Wandtafeln entnehmen Sie der Preisliste aus der Kategorie „Wandtafeln“
- Benötigen Sie ein einzelnes Passepartout ohne Bilderrahmen, erfragen Sie bitte die Preise bei unserem Innendienst.



PP	Design	Bilder	Größe
Einzel	4226	4x 10x15	30x30
Doppel	5226	4x 10x15	30x30

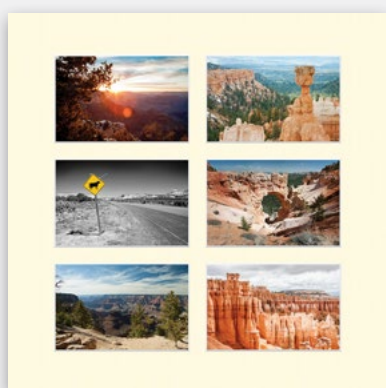

PP	Design	Bilder	Größe
Einzel	4230	6x 10x15	40x40
Doppel	5230	6x 10x15	40x40

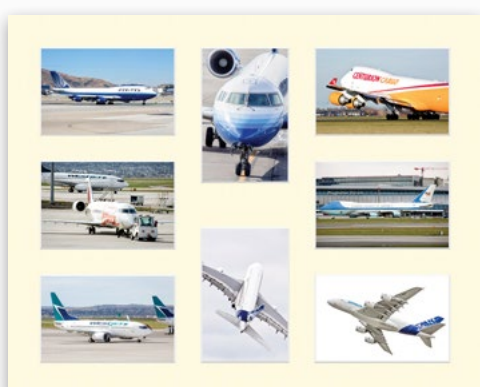

PP	Design	Bilder	Größe
Einzel	4231	8x 10x15	40x50
Doppel	5231	8x 10x15	40x50

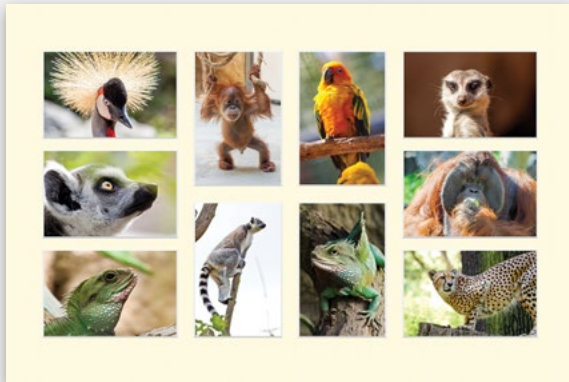

PP	Design	Bilder	Größe
Einzel	4232	10x 10x15	40x60
Doppel	5232 a	10x 10x15	40x60



PP	Design	Bilder	Größe
Einzel	4233	9x 10x15 4x10x10	40x60
Doppel	5233	9x 10x15 4x10x10	40x60



PP	Design	Bilder	Größe
Einzel	4244	24x 10x15	60x80
Doppel	5244	24x 10x15	60x80

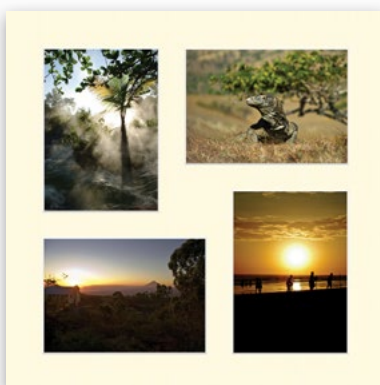

PP	Design	Bilder	Größe
Einzel	4229	4x 13x18	40x40
Doppel	5229	4x 13x18	40x40



PP	Design	Bilder	Größe
Einzel	4236	6x 13x18	50x50
Doppel	5236	6x 13x18	50x50



PP	Design	Bilder	Größe
Einzel	4238	9x 13x18	50x70
Doppel	5238 a	9x 13x18	50x70



PP	Design	Bilder	Größe
Einzel	4239	10x 13x18	50x70
Doppel	5239	10x 13x18	50x70



PP	Design	Bilder	Größe
Einzel	4240	10x 13x18	50x70
Doppel	5240	6x 13x18	50x70
		4x 10x15	



PP	Design	Bilder	Größe
Einzel	4241	8x 13x18	50x60
Doppel	5241	8x 13x18	50x60



PP	Design	Bilder	Größe
Einzel	4243	12x 13x18	60x80
Doppel	5243	12x 13x18	60x80

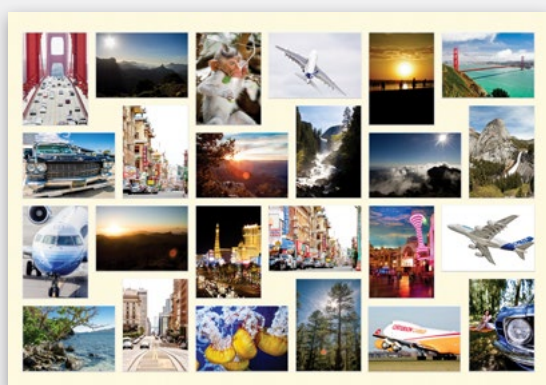

PP	Design	Bilder	Größe
Einzel	4246	24x 13x18	70x100
Doppel	5246	24x 10x15	70x100

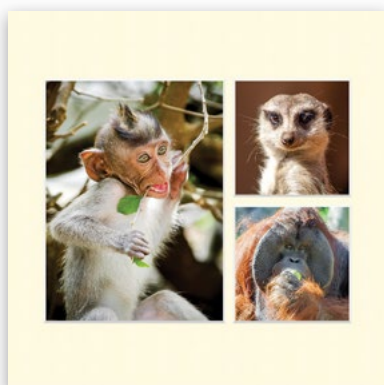

PP	Design	Bilder	Größe
Einzel	4225	1x 15x20 2x10x10	30x30
Doppel	5225	1x 15x20 2x 8,5x8,5	30x30

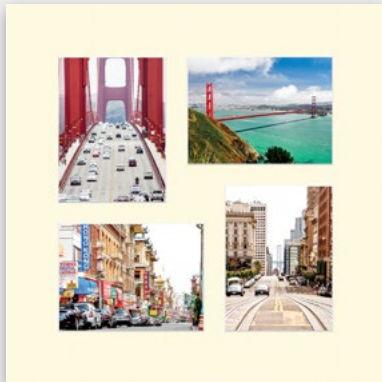

PP	Design	Bilder	Größe
Einzel	4235	4x 15x20	50x50
Doppel	5235	4x 15x20	50x50

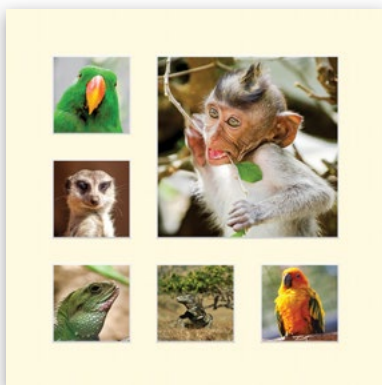

PP	Design	Bilder	Größe
Einzel	4227	1x 20x20 5x 9x9	40x40
Doppel	5227	1x 20x20 5x 9x9	40x40

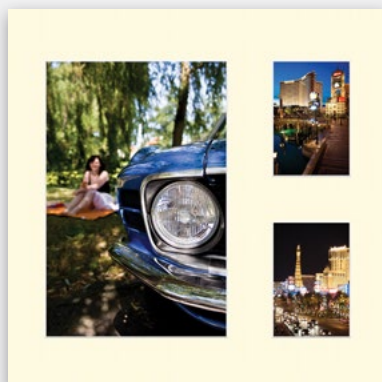

PP	Design	Bilder	Größe
Einzel	4228	1x 20x30 2x 9x13	40x40
Doppel	5228	1x 20x30 2x 9x13	40x40

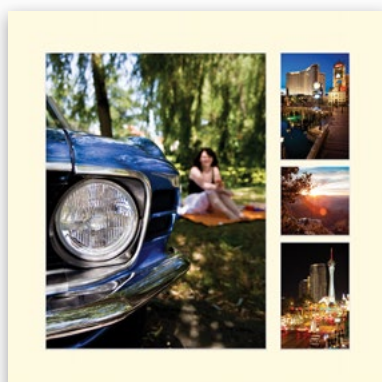

PP	Design	Bilder	Größe
Einzel	4234	1x 30x40 2x 10x15 1x10x10	50x50
Doppel	5234	1x 30x40 2x 9x13 1x 9x9	50x50

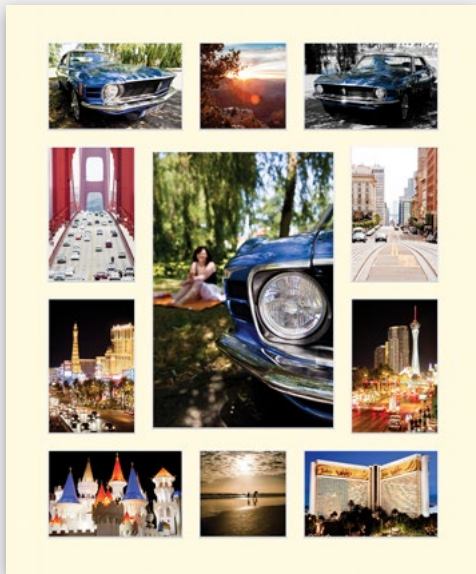

PP	Design	Bilder	Größe
Einzel	4237	1x 20x30 8x 10x15 2x 10x10	50x60
Doppel	5237	1x 20x30 8x 10x15 2x 10x10	50x60



PP	Design	Bilder	Größe
Einzel	4242	1x 30x40 12x 10x15	60x80
Doppel	5242	1x 30x40 12x 10x15	60x80



Passbildmappen 4,5 x 6,5 cm

Mindestbestellung

100 Stk = 1 VE

Ab 500 Stück = 5 VE

Rabatt möglich!

Bitte beim Außen- oder Innendienst anfragen.

Leichte Farbabweichung auf Grund unterschiedlicher Chargen möglich.

Verkaufs-, Zahlungs- und Lieferbedingungen

Kurzfassung

1. Preise und Versand

Die Preise verstehen sich ohne gesetzliche Mehrwertsteuer und sind in Euro angegeben. Die Lieferungen erfolgen unfrei ab Werk, auf Rechnung und auf Gefahr des Käufers.

2. Mindestbestellwerte

Wir verzichten auf Mindestbestellwerte.

3. Versandkosten und Verpackungskosten

Wir berechnen pro Auftrag 4,90 € Verpackungskosten.

Versandkosten Deutschland

Lieferung mit Paketdienst

Bis 349,99 € 9,90 €

Ab 350,00 € frei Haus

Lieferung mit Spedition 29,95 €

Inselzuschlag pro Paket 10,00 €

Inselzuschlag Spedition auf Anfrage

Versandkosten Österreich

Lieferung mit Paketdienst

Bis 499,99 € 13,90 €

Ab 500,00 € frei Haus

Lieferung mit Spedition 45,00 €

Stangenware wird ausschließlich per Spedition verschickt und kann nicht in zwei Lieferungen geteilt werden.

4. Zahlungsbedingungen

Rechnungen sind innerhalb von 10 Tagen mit 2 % Skonto oder innerhalb von 30 Tagen netto zu bezahlen. Bei Bankeinzug gewähren wir bei Zahlung innerhalb von 10 Tagen 2 % Skonto. Bei Zahlungen nach Fälligkeit sind wir berechtigt, Verzugszinsen in Höhe von 1% der Restschuld pro Monat der ausstehenden Zahlung sowie Mahngebühren zu verlangen.

5. Lieferzeit

Wir sind bemüht, bestellte Ware schnellstmöglich auszuliefern, ohne jedoch eine Haftung für die Einhaltung gegebener Lieferzeiten zu übernehmen. Zwischenverkauf und Preisänderung behalten wir uns vor. Wir informieren bei Bestellung über eventuelle Preisänderungen.

6. Eigentumsvorbehalt

Die Robert Richter GmbH behält das Eigentum an allen von ihr gelieferten Waren bis zur Bezahlung sämtlicher Forderungen aus der Geschäftsbeziehung. Der Käufer darf die unter Eigentumsvorbehalt stehende Ware keinem Dritten verpfänden oder übereignen.

7. Reklamationen

Beanstandungen der gelieferten Ware müssen unverzüglich, spätestens innerhalb von 8 Tagen, unter Angabe von Rechnungs - und Kundennummer, angezeigt werden. Geringfügige Abweichungen in Form und Farbe sind unvermeidlich und berechtigen nicht zur Reklamation. Für vom Verkäufer anerkannte Reklamationen erhält der Käufer Ersatz oder Gutschrift nach Wahl des Verkäufers.

8. Gerichtsstand

Erfüllungsort und Gerichtsstand für alle sich aus dem Vertragsverhältnis ergebenden Streitigkeiten ist DRESDEN.

Dresden, 23.08.2017

9. AGB

Unabhängig von dieser Kurzfassung gelten unsere ausführlichen AGBs.

LÜCK Bilderrahmen
Robert Richter GmbH
Tharandter Straße 38
01159 Dresden

Telefon +49(0)351 89 673 050
Telefax +49(0)351 42 438 137
service@lueck-rahmen.de

LÜCK 
Bilderrahmen